

ABOUTWATER AF/21

Istruzioni / Instructions / Instructions de montage / Bedienungsanleitung / Instrucciones

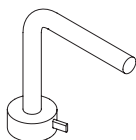

ART. A004WF

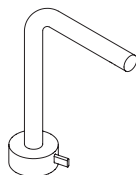

ART. A006WF

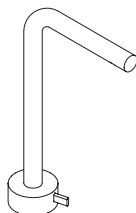

ART. A007WF

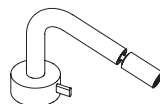

ART. A008WF

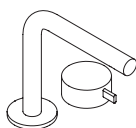

ART. A104WF

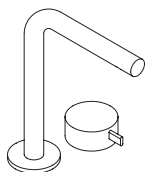

ART. A106WF

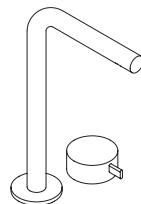

ART. A107WF

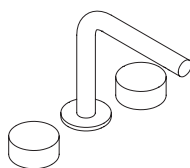

ART. A204WF

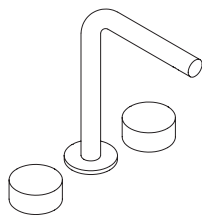

ART. A206WF

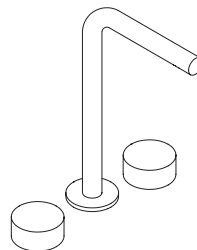

ART. A207WF

Montaggio flessibili / Flexible mounting



Prima dell'installazione controllare la presenza e l'integrità delle graffature dei flessibili da ambo i lati.

/ Before installation, check presence and integrity of the clamping of the side tubes.

1.

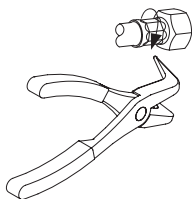

Non serrare con utensili non adatti o in punti non corretti.

/ Do not tighten by inappropriate tools or in inappropriate ways.

3.

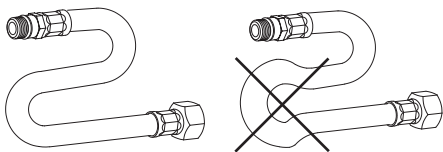

Rispettare il raggio minimo di curvatura.

/ Maintain minimum bend radius.

DN6 = 25 mm DN8 = 30 mm
DN10 = 35 mm DN13 = 45 mm

5.



Avvitare i raccordi con tenuta O.R. a mano.

Coppia massima di serraggio 3 Nm.

/ Hand-tighten O-ring seal connectors.

Max torque 3 Nm.

2.

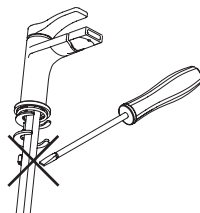

Dopo il montaggio evitare sollecitazioni laterali anche minime, con qualsiasi utensile.

(Es.: durante il fissaggio del tirante o astina).

/ Do not expose the hose to lateral stress nor overtight by any tool. (Ex.: during the installation of the faucet stud or the drain pop-up lever).

4.

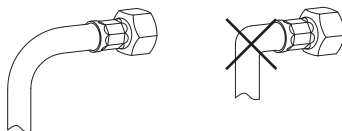

Prima dell'inizio della curvatura lasciare un tratto rettilineo di almeno 1,5 - 2 volte il diametro esterno.

/ Before bending the hose please consider a straight part of at least 1,5-2 times the external diameter.

6.

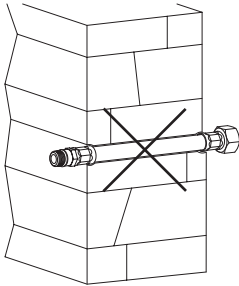

Non incassare il condotto nel muro.
/ Do not set the hose in the wall.

7.



Non installare il flessibile in torsione o in tensione.
/ Tighten the hose without any twist or tension.

8.

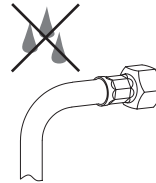

Il contatto prolungato con sostanze, pur blandamente aggressive, può determinare il danneggiamento della treccia ed il conseguente scoppio del flessibile.

/ Prolonged contact with any substance, even scarcely aggressive, can cause external braid damage and subsequent flexible burst.



Avvitare i raccordi con tenuta a guarnizione (dadi) a mano più 1/4 di giro con chiave appropriata.

/ Hand-tighten connectors with gasket seal (nuts) then apply 1/4 turn using an appropriate wrench.

9.

10.

Non collegare la messa a terra dell'impianto elettrico al flessibile o ad altra condotta idraulica.

Chiudere l'impianto idraulico in caso di prolungata assenza. Sostituire il flessibile in caso di piccole perdite.

/ Do not connect the electric grounding to the flexible hose nor to any other water piping.

Turn off the plumbing in case of long absence. Replace the hose in case of leakage and anyway.

11.

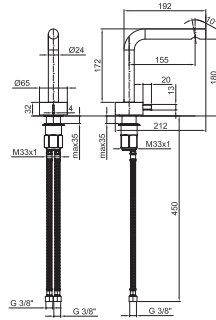

ART. A004WF Gruppo lavabo / Washbasin / Lavabo 1 trous / Waschtischarmatur / Lavabo

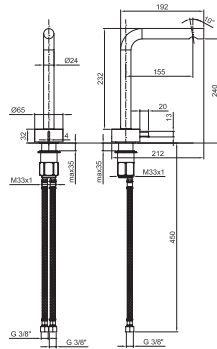

ART. A006WF Gruppo lavabo / Washbasin / Lavabo 1 trous / Waschtischarmatur / Lavabo

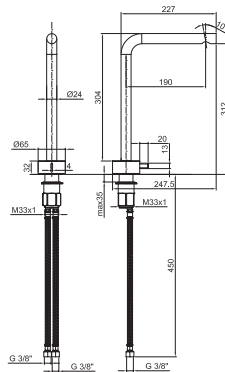
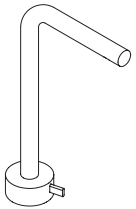

ART. A007WF Gruppo lavabo / Washbasin / Lavabo 1 trous / Waschtischarmatur / Lavabo

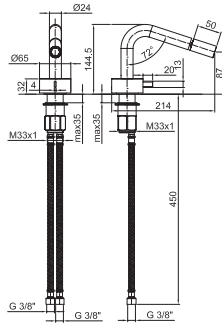
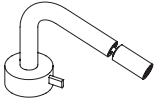

ART. A008WF Bidet monoforo / 1 hole bidet / Mélangeur bidet / Einlochbidet / Monobloc bidé

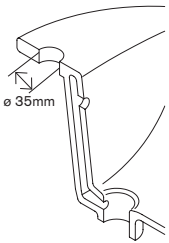

1.

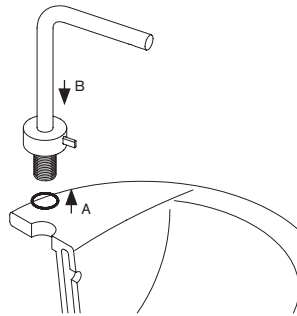

2.

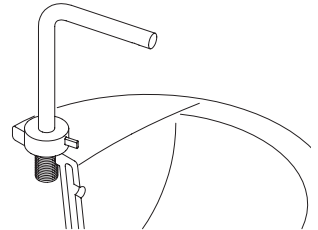

3.

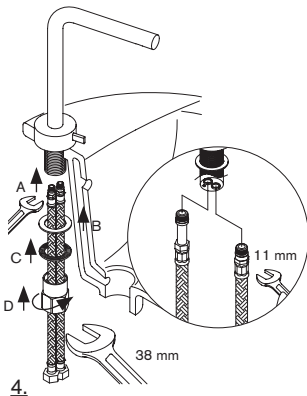

4.

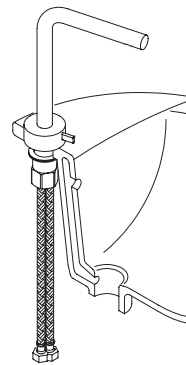

5.

Regolazioni / Adjustments / Ajustements / Anpassungen / Ajustes

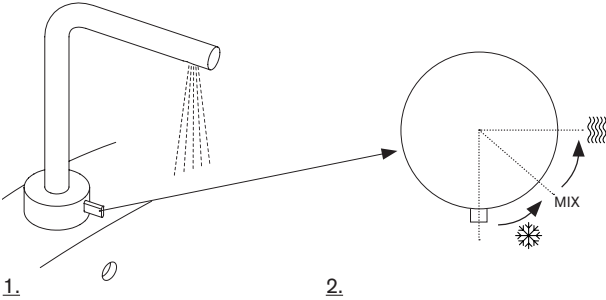

Sostituzione cartuccia / Cartridge replacement / Remplacement de la cartouche
 Auswechseln der Kartusche / Sustitucion del cartucho

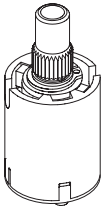

ART. 9000A070 Per art. A004WF - A006WF - A007WF - A008WF
 Sostituzione cartuccia / Cartridge replacement / Remplacement de la cartouche
 Auswechseln der Kartusche / Sustitucion del cartucho

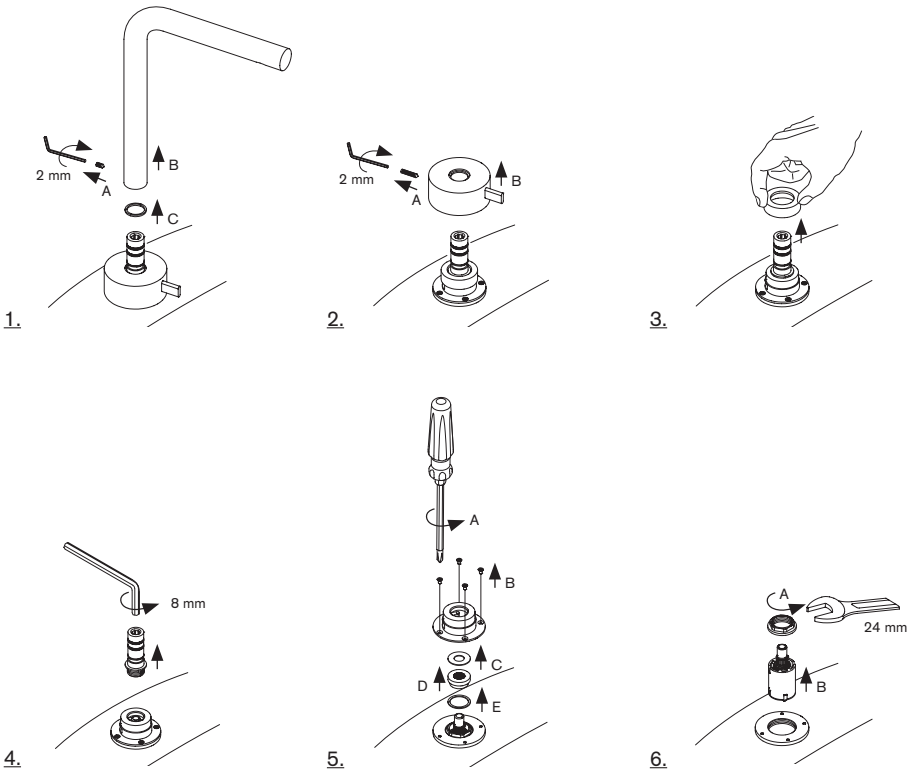

Rimontare seguendo il procedimento inverso (6-5-4-3-2-1). Serrare la ghiera (6) con una coppia di 10÷12 Nm.
 Replace following the instructions in reverse order (6-5-4-3-2-1). Tighten the ring (6) with a pair of 10÷12 Nm.
 Re-installer au contraire du procédé (6-5-4-3-2-1). Serrer l'écrou (6) avec une paire de 10÷12 Nm.
 Die umgekehrte Vorgehensweise folgen um die Teil wieder zu installieren (6-5-4-3-2-1). Ziehen Sie die Mutter (6) mit einem Paar von 10÷12 Nm.
 Colocar según el procedimiento inverso (6-5-4-3-2-1). Apretar la tuerca (6) con un par de 10÷12 Nm.

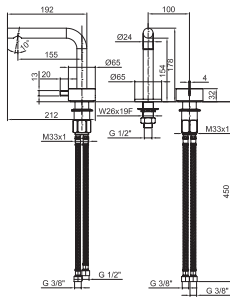
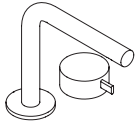

ART. A104WF Gruppo lavabo / Washbasin / Lavabo 1 trous / Waschtischarmatur / Lavabo

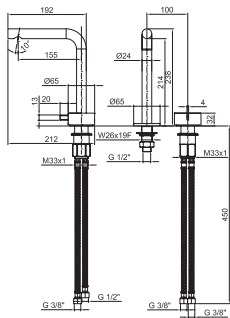
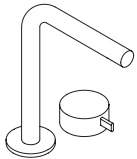

ART. A106WF Gruppo lavabo / Washbasin / Lavabo 1 trous / Waschtischarmatur / Lavabo

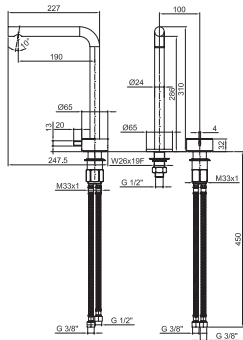
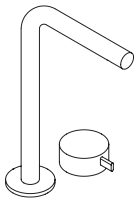

ART. A107WF Gruppo lavabo / Washbasin / Lavabo 1 trous / Waschtischarmatur / Lavabo

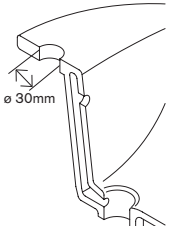

1.

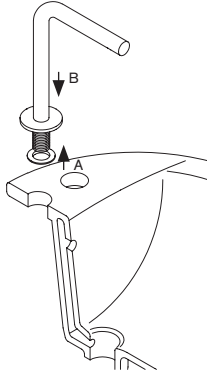

2.

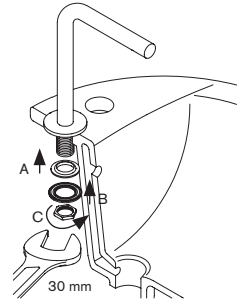

3.

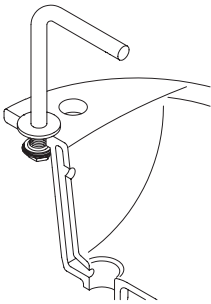

4.

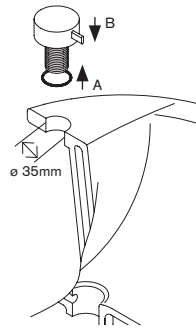

5.

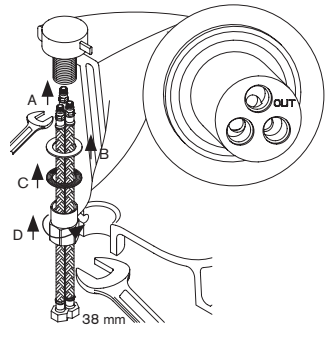

6.

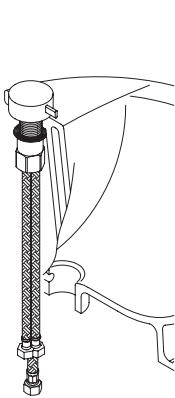

4.

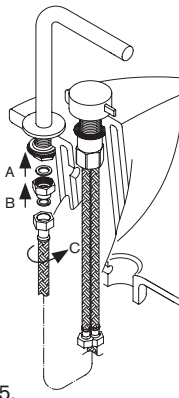

5.

Regolazioni / Adjustments / Ajustements / Anpassungen / Ajustes

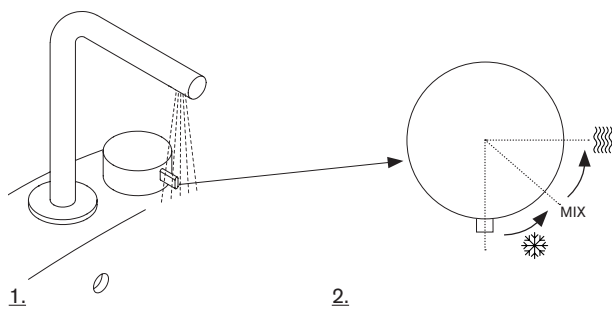

Sostituzione cartuccia / Cartridge replacement / Remplacement de la cartouche
Auswechseln der Kartusche / Sustitucion del cartucho

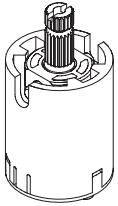

ART. 9000A170 Per art. A104WF - A106WF - A107WF

Sostituzione cartuccia / Cartridge replacement / Remplacement de la cartouche
Auswechseln der Kartusche / Sustitucion del cartucho

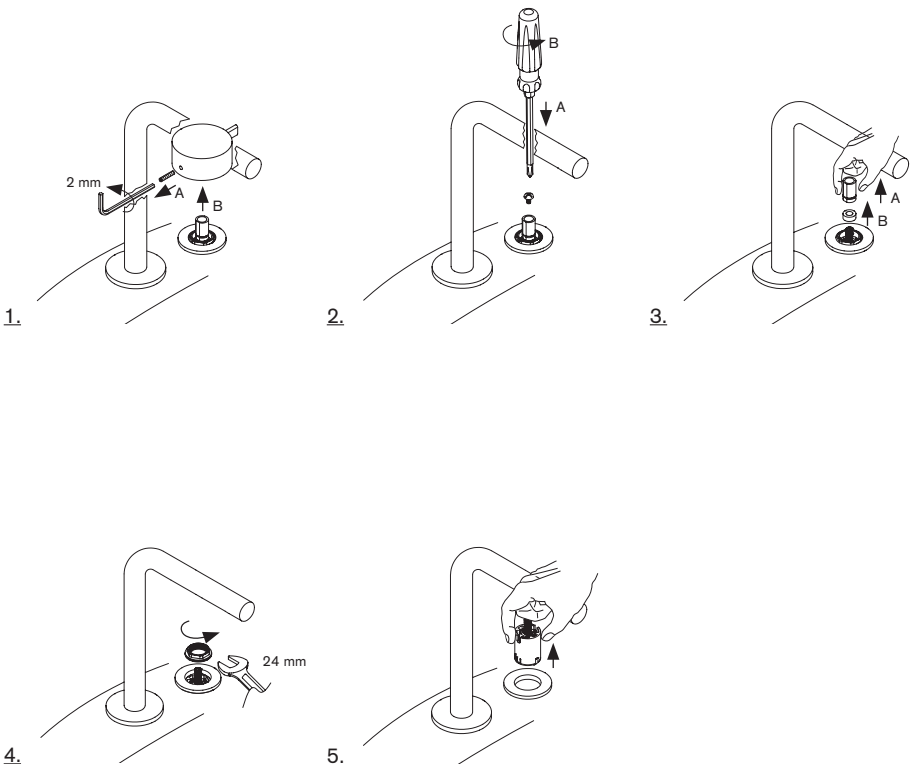

Rimontare seguendo il procedimento inverso (5-4-3-2-1). Serrare la ghiera (4) con una coppia di 10÷12 Nm.
Replace following the instructions in reverse order (5-4-3-2-1). Tighten the ring (4) with a pair of 10÷12 Nm.
Re-installer au contraire du procédé (5-4-3-2-1). Serrer l'écrou (4) avec une paire de 10÷12 Nm.

Die umgekehrte Vorgehensweise folgen um die Teil wieder zu installieren (5-4-3-2-1). Ziehen Sie die Mutter (4) mit einem Paar von 10÷12 Nm.

Colocar según el procedimiento inverso (5-4-3-2-1). Apretar la tuerca (4) con un par de 10÷12 Nm.

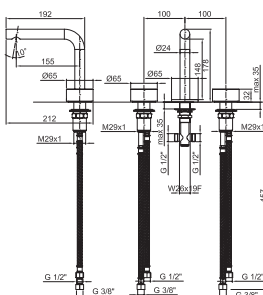
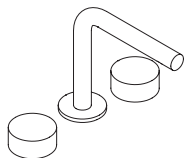

ART. A204WF Gruppo lavabo / Washbasin / Lavabo 1 trous / Waschtischarmatur / Lavabo

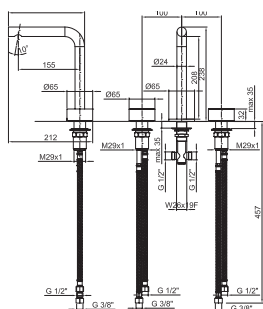
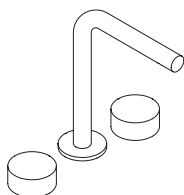

ART. A206WF Gruppo lavabo / Washbasin / Lavabo 1 trous / Waschtischarmatur / Lavabo

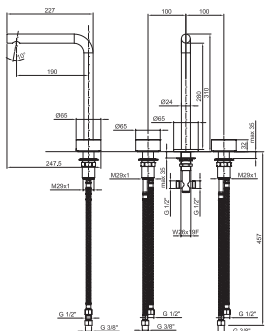
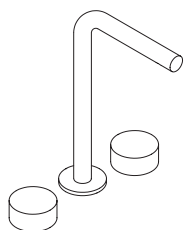

ART. A207WF Gruppo lavabo / Washbasin / Lavabo 1 trous / Waschtischarmatur / Lavabo

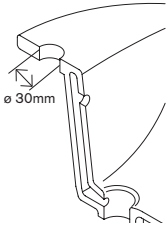

1.

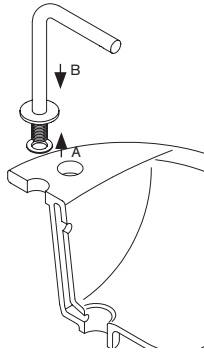

2.

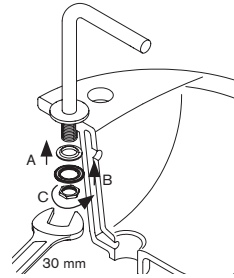

3.

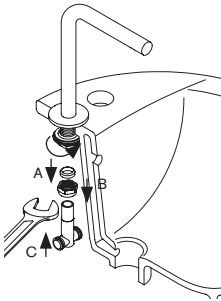

4.

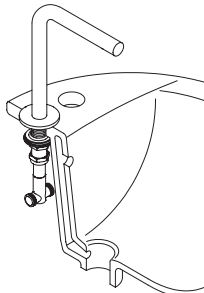

5.

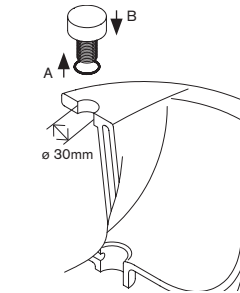

6.

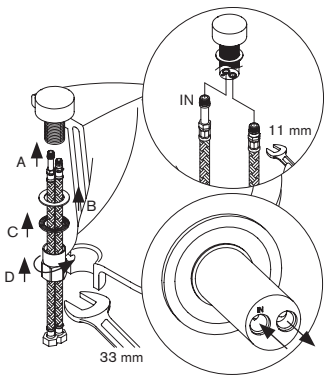

7.

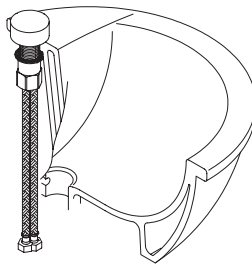

8.

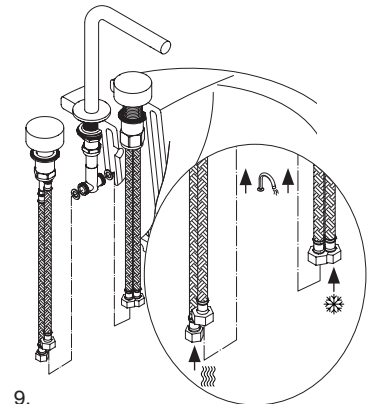

9.

Regolazioni / Adjustments / Ajustements / Anpassungen / Ajustes

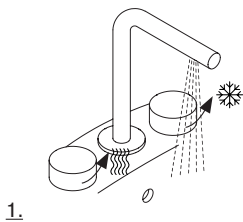

Sostituzione vitone / Bolt Replacement / Remplacement de la tête
Oberteilersetzung / Sustitucion rosca de extrusion

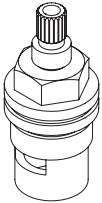

ART. 90000892 Per art. A204WF - A206WF - A207WF
Sostituzione vitone / Bolt replacement / Remplacement de la tête
Oberteilersetzung / Sustitucion rosca de extrusion

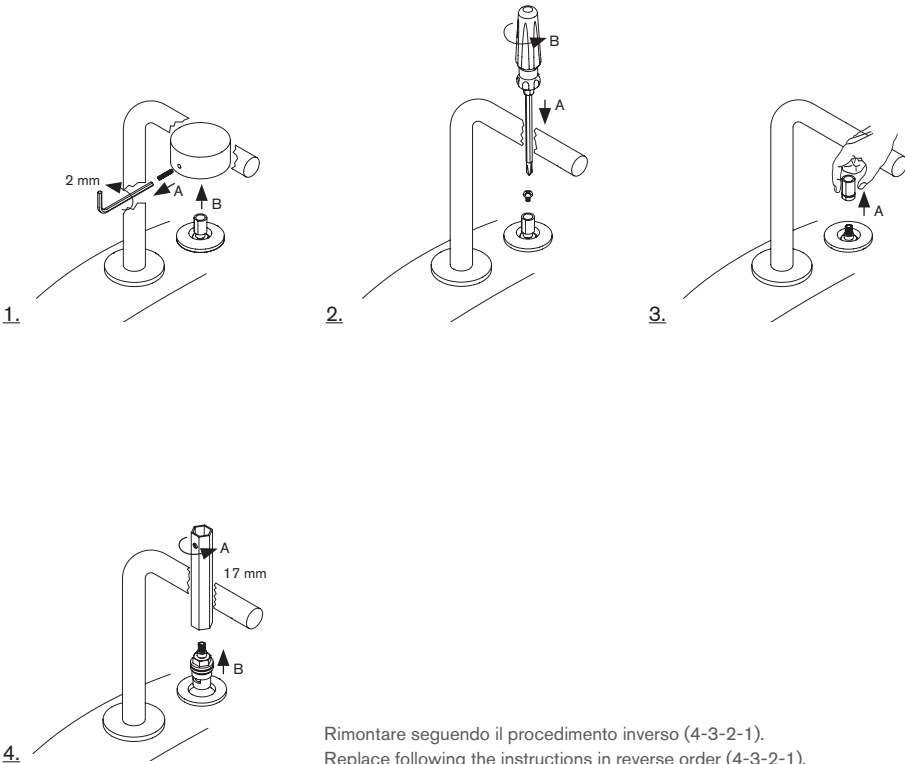

Rimontare seguendo il procedimento inverso (4-3-2-1).
Replace following the instructions in reverse order (4-3-2-1).
Re-installer au contraire du procédé (4-3-2-1).
Die umgekehrte Vorgehensweise folgen um die Teil wieder zu installieren (4-3-2-1).
Colocar según el procedimiento inverso (4-3-2-1).

Manutenzione / Maintenance / Entretien / Entretien / Mantenimiento



ART. 90009793 Per art. A004WF - A006WF - A007WF - A104WF - A106WF - A107WF
A204WF - A206WF - A207WF

Sostituzione aeratore / Substitute aerator / Remplacement de l'aérateur
Den Lüfter auswechseln / Sustituir el aireador

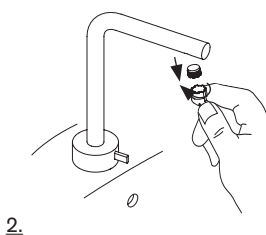
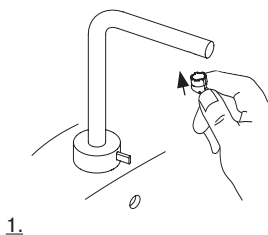

Rimontare seguendo il procedimento inverso (2-1)

Replace following the instructions in reverse order (2-1)

Re-installer au contraire du procédé (2-1)

Die umgekehrte Vorgehensweise folgen um die Teil wie der zu installieren (2-1)

Colocar según el procedimiento inverso (2-1)

Manutenzione / Maintenance / Entretien / Entretien / Mantenimiento



ART. 90009793 Per art. A008WF
Sostituzione aeratore / Substitute aerator / Remplacement de l'aérateur
Den Lüfter auswechseln / Sustituir el aireador

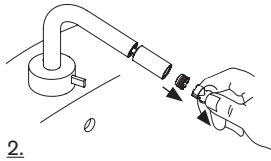
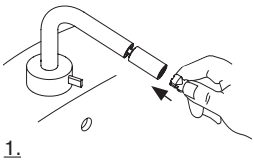

Rimontare seguendo il procedimento inverso (2-1)
Replace following the instructions in reverse order (2-1)
Re-installer au contraire du procédé (2-1)
Die umgekehrte Vorgehensweise folgen um die Teil wie der zu installieren (2-1)
Colocar según el procedimiento inverso (2-1)

Dati tecnici

Pressione minima	1 BAR
Pressione massima	10 BAR
Pressione di esercizio consigliata	2-5 BAR
Temperatura massima	80°
Temperatura massima consigliata	65°
Differenza massima di pressione in arrivo (calda - fredda)	1.5 BAR

Applicazioni

Questi miscelatori possono essere utilizzati con accumulatori di acqua calda a pressione o con scaldabagni istantanei.

Avvertenze

Prima di installare é necessario spurgare in modo accurato le tubazioni di alimentazione.

Ricordarsi che l'acqua calda deve essere

SEMPRE collegata al tubetto o flessibile di **SINISTRA**.

ITALY.**Dati tecnici**

Minimum pressure	1 BAR
Maximum pressure	10 BAR
Recommended working pressure	2-5 BAR
Maximum water temperature	80°
Maximum water temperature recommended	65°
Maximum in-let pressure difference (hot - cold)	1.5 BAR

Operating instructions

These mixers can be used with cumulos boilers or instantaneous water heaters.

Warning

The supplying pipes must be carefully cleaned before installation.

Remember that the hot water supply must **ALWAYS** be connected to the tube on the **LEFT**.

ENGLAND.**Caractéristiques techniques**

Pression minimum	1 BAR
Pression maximum	10 BAR
Pression optimale de service	2-5 BAR
Température maximum	80°
Température maximum optimale	65°
Différence maximum de Pression d'arrivée (chaud - froid)	1.5 BAR

Mode d'emploi

Ces mitigeurs peuvent être utilisés avec accumulateurs d'eau chaude à pression ou avec des chauffe-eau instantanés.

Note

Il est indispensable que les raccords d'alimentation soient purgés avant la mise en place de l'appareil.

Se rappeler que l'eau chaude doit être **TOUJOURS** liée au petit tuyau ou au flexible de **GAUCHE**.

FRANCE.**Technische Daten**

Minimum druck	1 BAR
Höchste druck	10 BAR
Empfehlener druck	2-5 BAR
Höchste wasser Temperatur	80°
Empfehlener höchste Wassertemperatur	65°
Höchste einkommende Drucksunterschied (Warm - kalt)	1.5 BAR

Betriebsanweisungen

Diese Mischer sind sowie für Heisswasserspeicher als auch für Durchlaufhitzer geeignet.

Note

Die Verbindungsröhre vor der Montage sorgfältig putzen.

Das warme Wasser muss **IMMER** mit dem linken

RÖHRCHEN ODER Flexschlauch verbunden werden

GERMANY.**Datos Técnicos**

Pression mínima	1 BAR
Pression máxima	10 BAR
Pression de trabajo aconsejada	2-5 BAR
Temperatura máxima	80°
Temperatura máxima aconsejada	65°
Diferencial máxima de presión de entrada (caliente - fria)	1.5 BAR

Aplicaciones

Estos monomandos pueden ser utilizados con acumuladores de agua caliente a presión.

Advertencias

Antes de conectar el monomando es necesario purgar correctamente la instalación hidráulica de alimentación de cualquier impureza que pueda tener.

Recuerde que el agua caliente debe ser **SIEMPRE** conectada al tubo o flexo de la **IZQUIERDA**.

SPAIN.

Cura del prodotto

La pulizia delle superfici va fatta utilizzando un sapone liquido diluito in acqua.

Non usare mai in nessun caso detersivi liquidi contenenti sostanze abrasive o a base di acido muriatico, spugne abrasive, aceto, ammoniaca, acetone, candeggina, acidi di uso domestico, disinfettanti vari.

ATTENZIONE! L'impiego di prodotti non consigliati può deteriorare irrimediabilmente le superfici, nel qual caso il produttore non risponderà del danno.

L'azienda si riserva in qualunque momento di apportare senza preavviso modifiche a prodotti e accessori. I dati riprodotti in questo documento hanno carattere informativo e non sono vincolanti.

ITALY.

Pflege hinweise unserer artikel

Zur Reinigung empfehlen wir Wasser und flüssige Seife.

Verwenden Sie bitte nie flüssige Reinigungsmittel, die Schmirgel, Salzsäure, Essig, Ammoniak, Aceton, Bleichlange, Desinfektionsmittel u.s.w. enthalten.

WARNUNG! Der Gebrauch solcher Mittel kann unsere Artikel beschädigen und in diesem Fall gewährt Hersteller keine Garantie.

Der Hersteller behalt sich das Recht vor jederzeit Änderungen an seinen Produkten und Zubehörteilen ohne Vorbescheid vorzunehmen. Katalogangaben sowie Abbindungen, Maß- und Leistungsangaben sind unverbindlich.

GERMANY.

Advice on product care

To clean the surface use a soap and water solution.

Never use for any reason cleaning solutions containing abrasive substances, chloric acids, ammonia, vinegar, bleach, domestic acids, disinfectants, or anytype of abrasive pad.

WARNING! Incorrect cleaning may permanently ruin the surface of the products and in such case the manufacturer may not be held liable for damage.

The Manufacturer reserves the right to modify product and accessories at any time without prior notice. Datas, products and sketches included in this document are just for information and do not bind the producer.

ENGLAND.

Consejos para el cuidado del producto

La limpieza de las superficies se hace utilizando un jabón líquido diluido en agua.

No usar en ningún caso detergentes líquidos que contengan sustancias abrasivas ó a base de ácido clorhídrico, estropajossabrosivos, amoniaco, acetona, lejía, ácidos de uso doméstico, desinfectantes varios.

ATENCIÓN! El uso de productos desaconsejados puede danar irremediablemente las superficies de los elementos, de lo cual el fabricante no se hará responsable en ningún caso.

La sociedad se reserva el derecho de modificar sus productos y accesorios en cualquier momento y sin previo aviso.

SPAIN.

Conseils pour l'entretien du produit

La poussiere en surface devra être faite en utilisant un savon liquide dilué dans l'eau.

Ne jamais utiliser en aucun cas des détergents liquides contenant des substances abrasives ou à base d'acide, nid'éponges abrasives, vinaigre, ammoniacque, acétone, eau de Javel, acides à usage domestique, désinfectants divers.

ATTENTION! L'empli de produits non conseillés peut détériorer irrémédiablement la surface des articles pour lesquels le fabricant ne sera pas responsable.

La société se réserve le droit de modifier ses produits et ses accessoires à tout moment et sans préavis. Informations, produits et croquis reproduits dans ce documents sont de nature informative et ne sont pas contractuels.

FRANCE.

ABOUT WATER

Disegni e grafica: www.dipi-designs.com 1127000010000000 Rev. 1



COMPANY WITH QUALITY MANAGEMENT
SYSTEM CERTIFIED BY DNV
= ISO 9001:2008 =

Australian Standard Installation

Products shall be installed in accordance with AS/NZS 3500 series of standards.
Installer shall ensure that the flow controlled aerator is tightened to prevent removal by hand.