

ART. 0556F

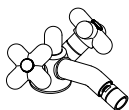

ART. 0562F

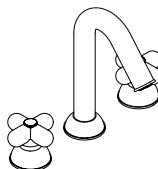

ART. 0504

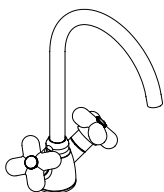

ART. 0550F

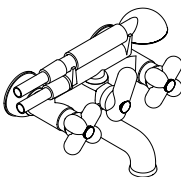

ART. 0515

Utensili necessari / Tools needed / Outils nécessaires / Werkzeuge benötigt / Instrumentos necesarios

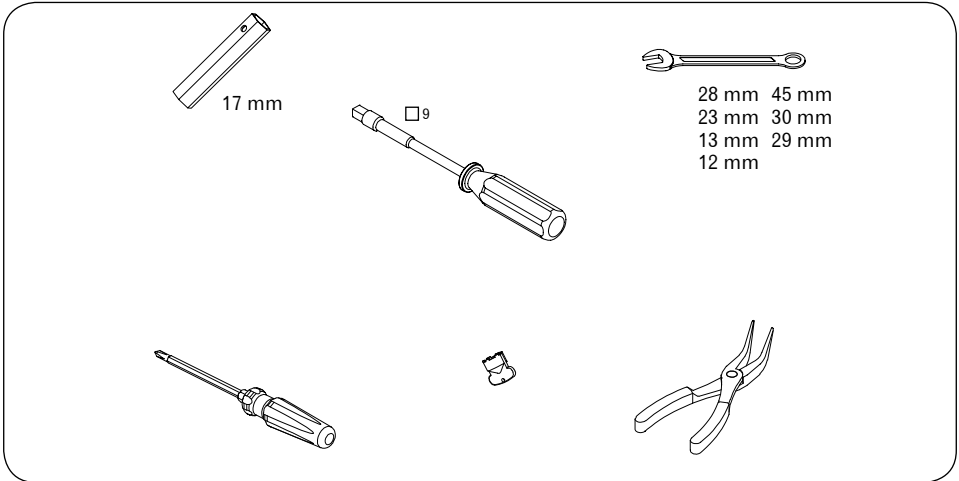

Indice / Index / Index / Übersicht / Índice

Montaggio flessibili / Flexible mounting	4
0556F Gruppo lavabo / Washbasin / Lavabo 1 trous / Waschtischarmatur / Lavabo	6
Regolazioni / Adjustments / Ajustements / Anpassungen / Ajustes	8
0562F Miscelatore bidet / Bidet Mixer / Mitigeur bidet / Einhand-Bidet Mischer / Monomando Bidet	10
Regolazioni / Adjustments / Ajustements / Anpassungen / Ajustes	12
0504 Gruppo lavabo / Washbasin / Lavabo 1 trous / Waschtischarmatur / Lavabo	14
Regolazioni / Adjustments / Ajustements / Anpassungen / Ajustes	17

0550F Gruppo lavello monoforo / 1 Hole sink mixer / Mélangeur évier monotrou / Einloch-Küchenarmatur / Monobloc fregadera	18
Regolazioni / Adjustments / Ajustements / Anpassungen / Ajustes	20
Sostituzione vitone / Bolt replacement / Remplacement de la tête / Oberteilersetzung / Sustitucion rosca de extrusion	21
Sostituzione aeratore / Substitute aerator / Remplacement de l'aérateur / Den Lüfter auswescseln / Sustituir el aireador	23
0515 Vasca esterno / Wall-mounted bathtub mixer / Bain-douche externe / Ap-Einhebel Wannenmischer / Baño ducha	26
Regolazioni / Adjustments / Ajustements / Anpassungen / Ajustes	28
Sostituzione vitone / Bolt replacement / Remplacement de la tête / Oberteilersetzung / Sustitucion rosca de extrusion	29
Sostituzione deviatore / Diverter replacement / Remplacement de inverseur / Auswechseln der Umsteller / Sustitucion del distribudor	30
Sostituzione aeratore / Substitute aerator / Remplacement de l'aérateur / Den Lüfter auswescseln / Sustituir el aireador	31
Dati tecnici / Technical data / Caractéristiques techniques / Technische Daten / Datos Técnicos	32

Montaggio flessibili / Flexible mounting.



Prima dell'installazione controllare la presenza e l'integrità delle graffiature dei flessibili da ambo i lati.

/ Before installation, check presence and integrity of the clamping of the side tubes.

1.

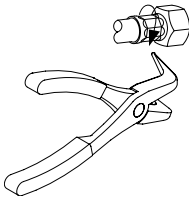

Non serrare con utensili non adatti o in punti non corretti.

/ Do not tighten by inappropriate tools or in inappropriate ways.

3.

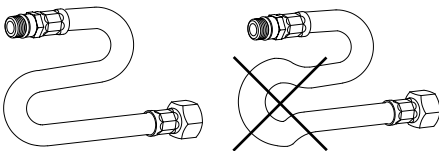

Rispettare il raggio minimo di curvatura.

/ Maintain minimum bend radius.

DN6 = 25 mm DN8 = 30 mm
DN10 = 35 mm DN13 = 45 mm

5.



Avvitare i raccordi con tenuta O.R. a mano. Coppia massima di serraggio 3 Nm.

/ Hand-tighten O-ring seal connectors. Max torque 3 Nm.

2.

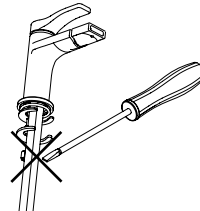

Dopo il montaggio evitare sollecitazioni laterali anche minime, con qualsiasi utensile.

(Es.: durante il fissaggio del tirante o astina).

/ Do not expose the hose to lateral stress nor overtight by any tool. (Ex.: during the installation of the faucet stud or the drain pop-up lever).

4.

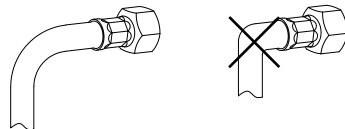

Prima dell'inizio della curvatura lasciare un tratto rettilineo di almeno 1,5 - 2 volte il diametro esterno.

/ Before bending the hose please consider a straight part of at least 1,5-2 times the external diameter.

6.

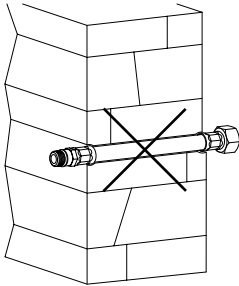

Non incassare il condotto nel muro.
/ Do not set the hose in the wall.

7.



Non installare il flessibile in torsione o in tensione.
/ Tighten the hose without any twist or tension.

8.

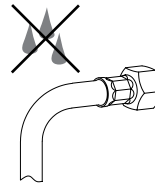

Il contatto prolungato con sostanze, pur blandamente aggressive, può determinare il danneggiamento della treccia ed il conseguente scoppio del flessibile.

/ Prolonged contact with any substance, even scarcely aggressive, can cause external braid damage and subsequent flexible burst.

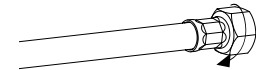

Avvitare i raccordi con tenuta a guarnizione (dadi) a mano più 1/4 di giro con chiave appropriata.
/ Hand-tighten connectors with gasket seal (nuts) then apply 1/4 turn using an appropriate wrench.

9.

10.

Non collegare la messa a terra dell'impianto elettrico al flessibile o ad altra condotta idraulica. Chiudere l'impianto idraulico in caso di prolungata assenza. Sostituire il flessibile in caso di piccole perdite.

/ Do not connect the electric grounding to the flexible hose nor to any other water piping.

Turn off the plumbing in case of long absence. Replace the hose in case of leakage and anyway.

11.

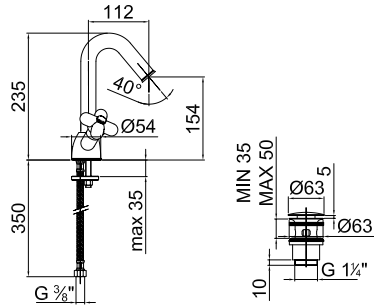
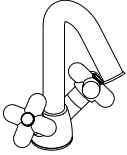

ART. 0556F

Gruppo lavabo / Washbasin / Lavabo 1 trous / Waschtischarmatur / Lavabo

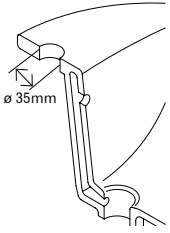

1.

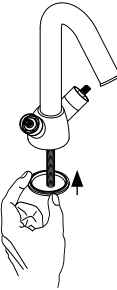

2.

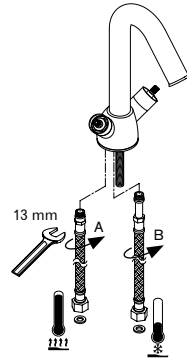

3.

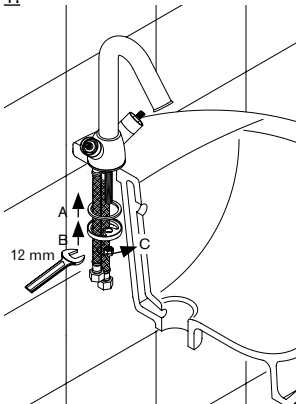

4.

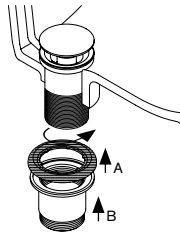

5.

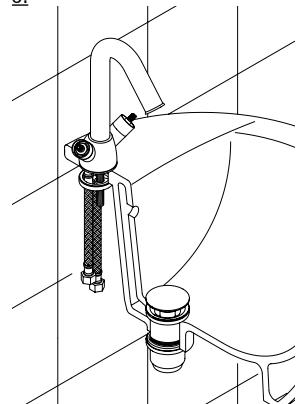

6.

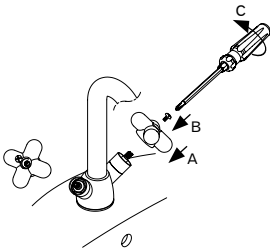

7.

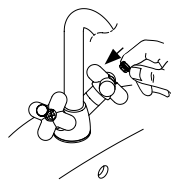

8.

Regolazioni / Adjustments / Ajustements / Anpassungen / Ajustes

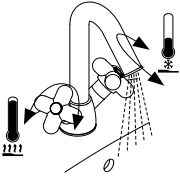

1.

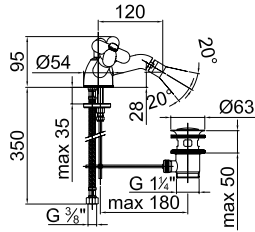
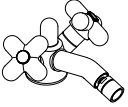

ART. 0562F

Bidet monoforo / 1-hole bidet mixer / Mélangeur bidet monotrou /
Monobloc bide / Einloch-Bidetarmatur

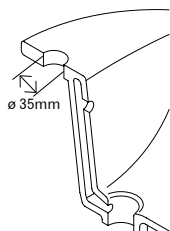

1.

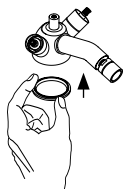

2.



3.

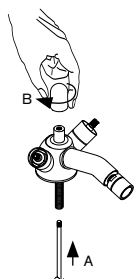

4.

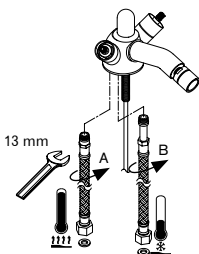

5.

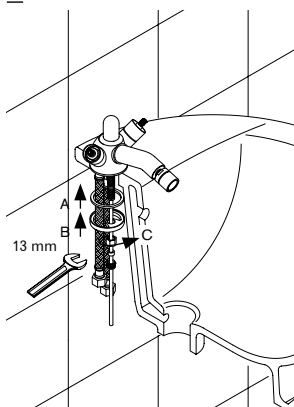

6.

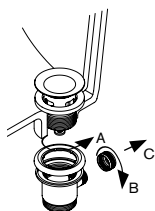

7.

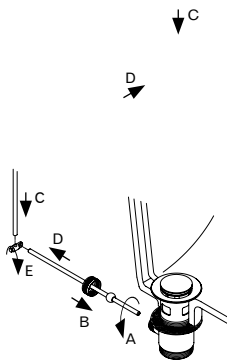

8.

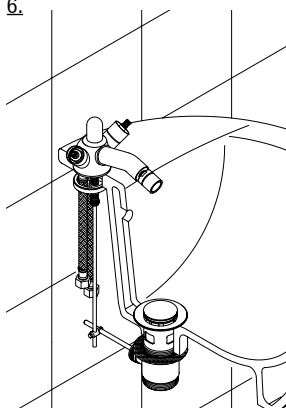

9.

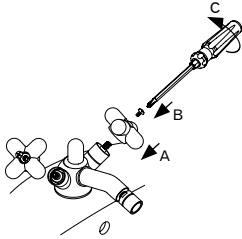

10.

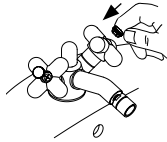

11.

Regolazioni / Adjustments / Ajustements / Anpassungen / Ajustes

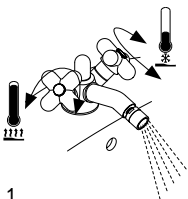

1.

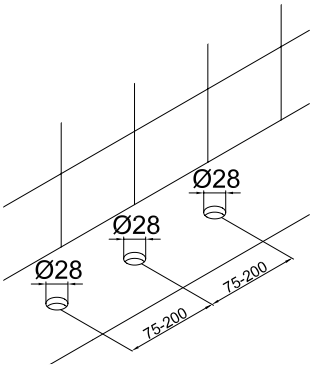

1.

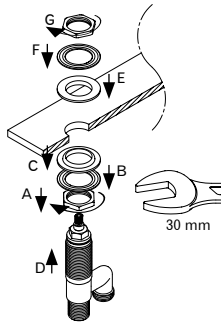

2.

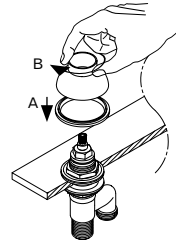

3.

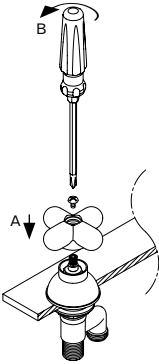

4.

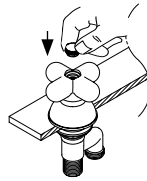

5.

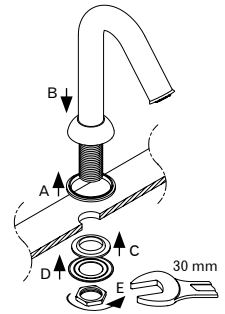

6.

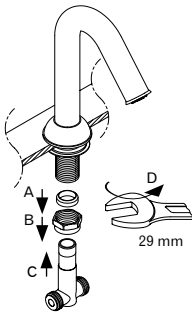

7.

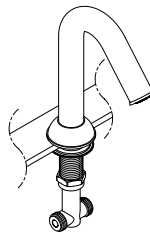

7.

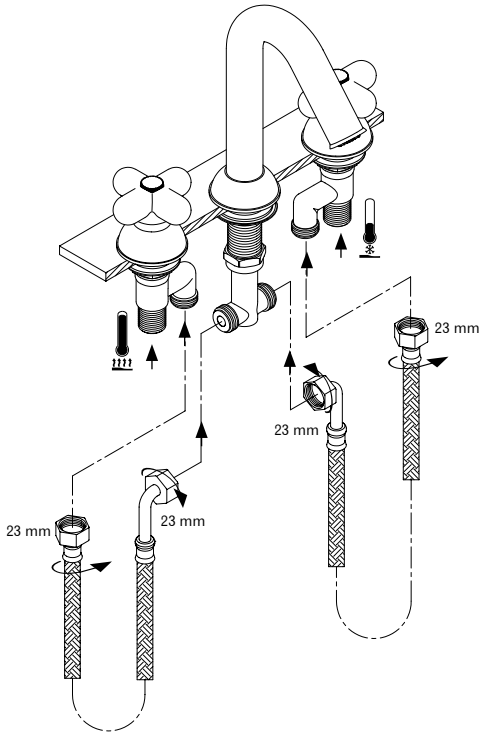

8.

Regolazioni / Adjustments / Ajustements / Anpassungen / Ajustes

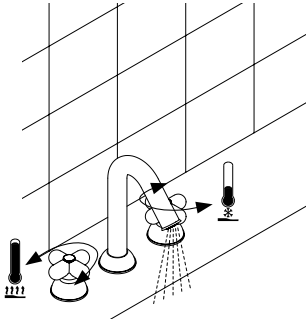

1.

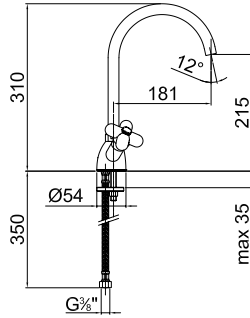
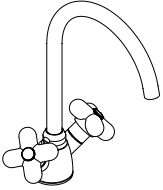

ART. 0550F

Gruppo lavello monoforo / 1 Hole sink mixer / Mélangeur évier monotrou / Einloch-Küchenarmatur / Monobloc fregadera

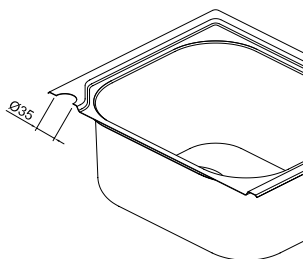

1.

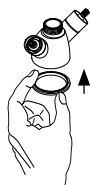

2.

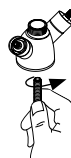

3.

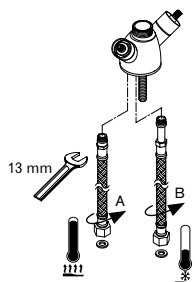

4.

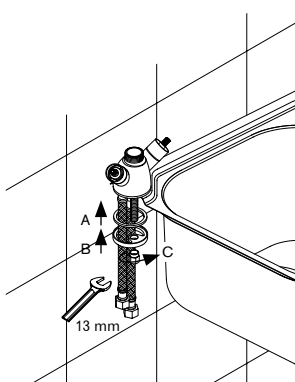

5.

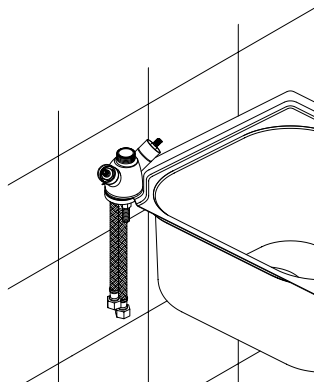

6.

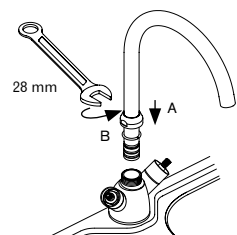

7.

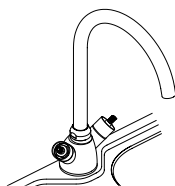

8.

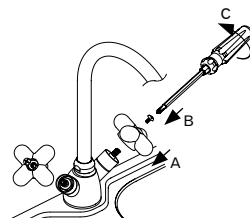

9.

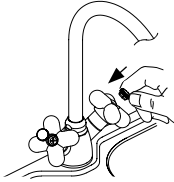

10.

Regolazioni / Adjustments / Ajustements / Anpassungen / Ajustes

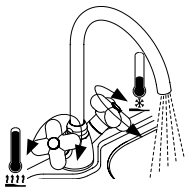

1.

Sostituzione vitone / Bolt Replacement / Remplacement de la tête
Oberteilersetzung / Sustitucion rosca de extrusion
 Per art. 0504

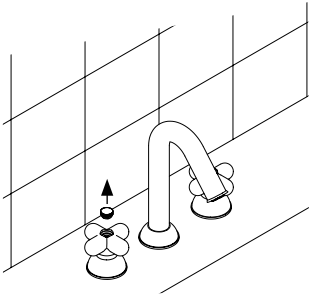

1.

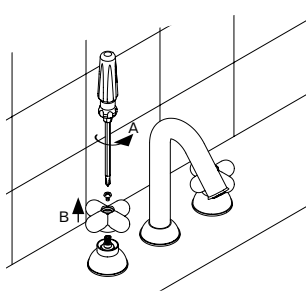

2.

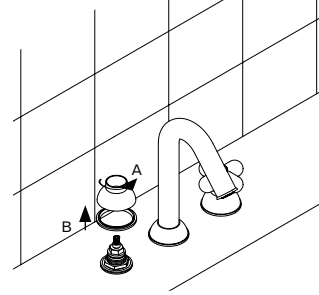

3.

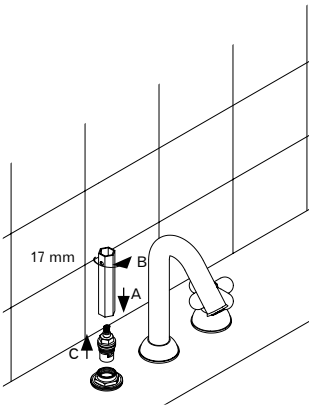

4.

Rimontare seguendo il procedimento inverso (4-3-2-1).
 Replace following the instructions in reverse order (4-3-2-1).
 Re-installer au contraire du procédé (4-3-2-1).
 Die umgekehrte Vorgehensweise folgen um die Teil wieder zu installieren (4-3-2-1).
 Colocar según el procedimiento inverso (4-3-2-1).

Sostituzione vitone / Bolt Replacement / Remplacement de la tête
Oberteilersetzung / Sustitucion rosca de extrusion
Per art. 0556F - 0562F - 0550F

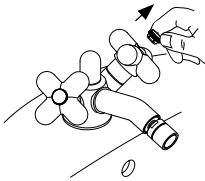

1.

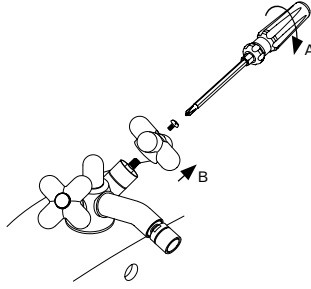

2.

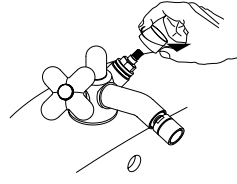

3.

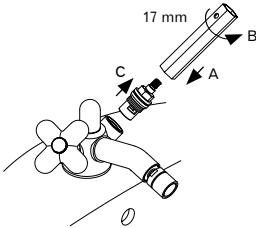

4.

Rimontare seguendo il procedimento inverso (4-3-2-1).
Replace following the instructions in reverse order (4-3-2-1).
Re-installer au contraire du procédé (4-3-2-1).
Die umgekehrte Vorgehensweise folgen um die Teil wieder zu installieren (4-3-2-1).
Colocar según el procedimiento inverso (4-3-2-1).

**Sostituzione aeratore / Substitute aerator / Remplacement de l'aérateur / Den
Lüfter auswesceln / Sustituir el aireador**
Per art. 0556F - 0504

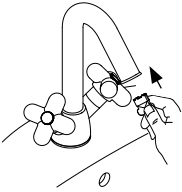

1.

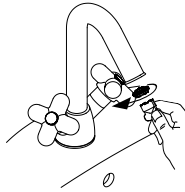

2.

Rimontare seguendo il procedimento inverso (2-1)
Replace following the instructions in reverse order (2-1)
Re-installer au contraire du procédé (2-1)
Die umgekehrte Vorgehensweise folgen um die Teil wie der zu installieren (2-1)
Colocar según el procedimiento inverso (2-1)

**Sostituzione aeratore / Substitute aerator / Remplacement de l'aérateur / Den
Lüfter auswesceln / Sustituir el aireador**
Per art. 0562F

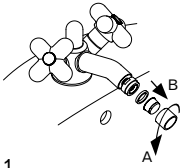

Rimontare seguendo il procedimento inverso (B-A)
Replace following the instructions in reverse order (B-A)
Re-installer au contraire du procédé (B-A)
Die umgekehrte Vorgehensweise folgen um die Teil wie der zu installieren (B-A)
Colocar según el procedimiento inverso (B-A)

**Sostituzione aeratore / Substitute aerator / Remplacement de l'aérateur / Den
Lüfter auswesceln / Sustituir el aireador**
Per art. 0550F

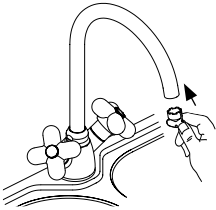

1.

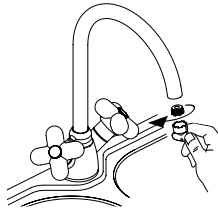

2.

Rimontare seguendo il procedimento inverso (2-1)
Replace following the instructions in reverse order (2-1)
Re-installer au contraire du procédé (2-1)
Die umgekehrte Vorgehensweise folgen um die Teil wie der zu installieren (2-1)
Colocar según el procedimiento inverso (2-1)

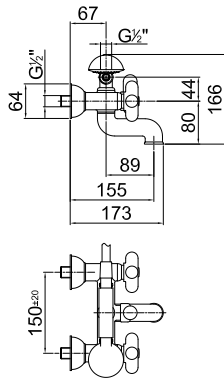
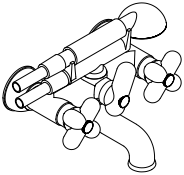

ART. 0515 Vasca esterno / Wall-mounted bathtub mixer / Bain-douche externe / AP-Einhebel Wannenmischer / Baño ducha

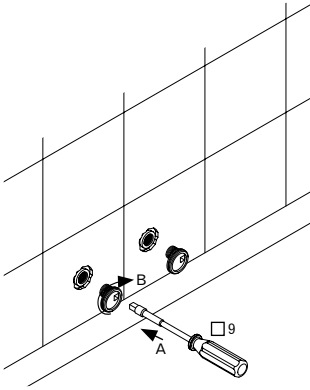

1.

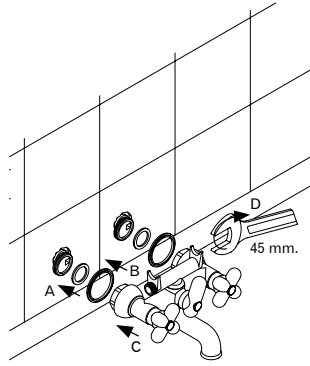

2.

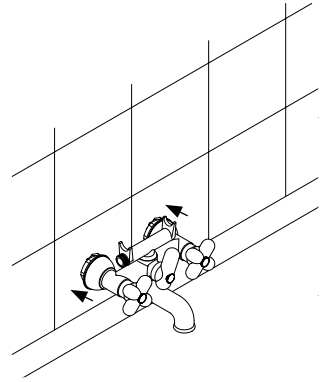

3.

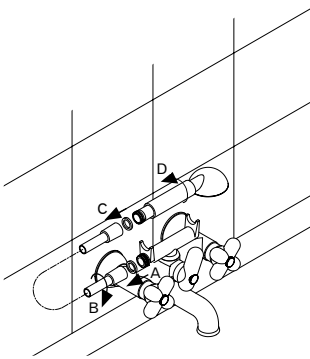

4.

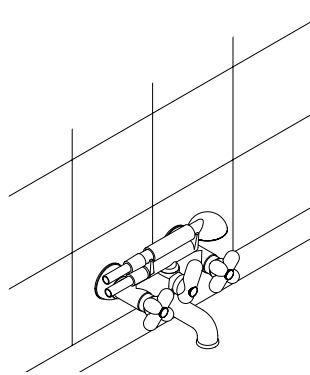

5.

Regolazioni / Adjustments / Ajustements / Anpassungen / Ajustes

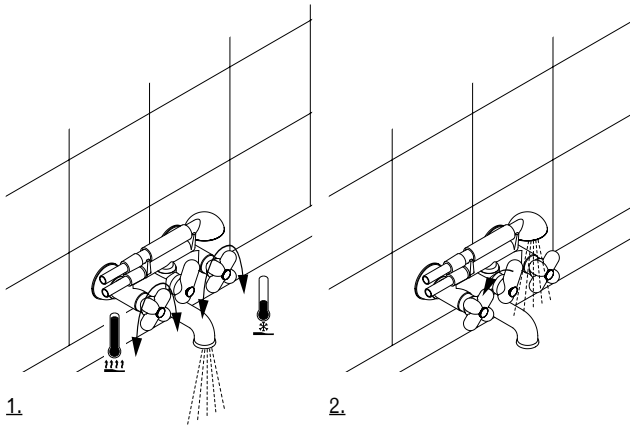

Sostituzione vitone / Bolt Replacement / Remplacement de la tête
 Oberteilersetzung / Sustitucion rosca de extrusion

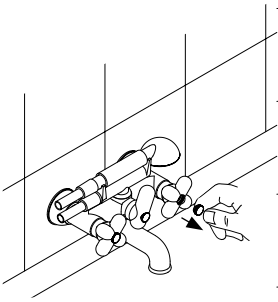

1.

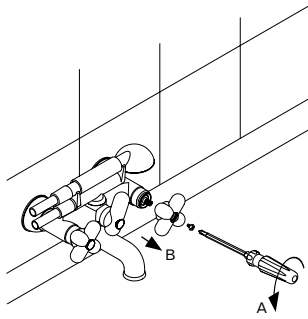

2.

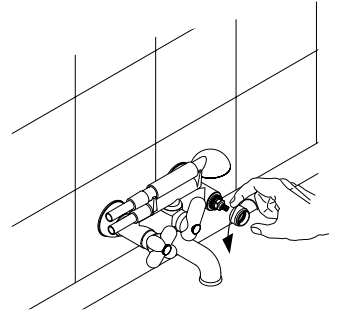

3.

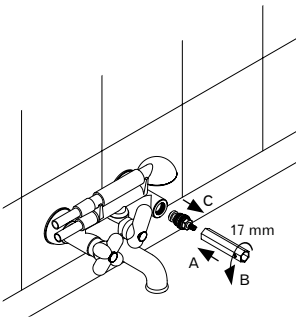

4.

Rimontare seguendo il procedimento inverso (4-3-2-1).
 Replace following the instructions in reverse order (4-3-2-1).
 Re-installer au contraire du procédé (4-3-2-1).
 Die umgekehrte Vorgehensweise folgen um die Teil wieder zu installieren (4-3-2-1).
 Colocar según el procedimiento inverso (4-3-2-1).

**Sostituzione deviatore / Diverter replacement / Remplacement de inverseur /
Auswechseln der Umsteller / Sostitucion del distribudor**

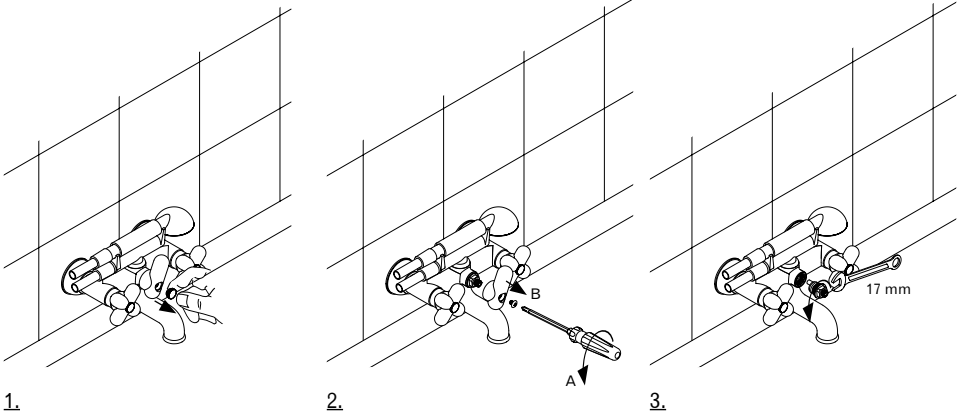

Rimontare seguendo il procedimento inverso (3-2-1).
Replace following the instructions in reverse order (3-2-1).
Re-installer au contraire du procédé (3-2-1).
Die umgekehrte Vorgehensweise folgen um die Teil wieder zu installieren (3-2-1).
Colocar según el procedimiento inverso (3-2-1).

Sostituzione aeratore / Substitute aerator / Remplacement de l'aérateur / Den
Lüfter auswesceln / Sustituir el aireador

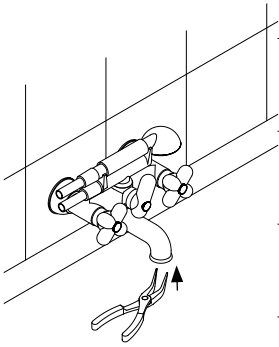

1.

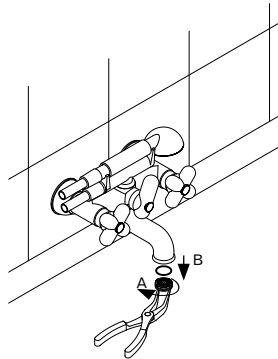

2.

Rimontare seguendo il procedimento inverso (2-1)
 Replace following the instructions in reverse order (2-1)
 Re-installer au contraire du procédé (2-1)
 Die umgekehrte Vorgehensweise folgen um die Teil wie der zu installieren (2-1)
 Colocar según el procedimiento inverso (2-1)

Dati tecnici

Pressione minima.....	1 BAR
Pressione massima.....	10 BAR
Pressione di esercizio consigliata.....	2-5 BAR
Temperatura massima.....	80°
Temperatura massima consigliata.....	65°
Differenza massima di pressione in arrivo (calda - fredda).....	1.5 BAR

Applicazioni

Questi miscelatori possono essere utilizzati con accumulatori di acqua calda a pressione o con scaldabagni istantanei.

Avvertenze

Prima di installare é necessario spurgare in modo accurato le tubazioni di alimentazione.

Ricordarsi che l'acqua calda deve essere **SEMPRE** collegata al tubetto o flessibile di **SINISTRA**.

Technische Daten

Minimum druck.....	1 BAR
Höchste druck.....	10 BAR
Empfehlener druck.....	2-5 BAR
Höchste wasser Temperatur.....	80°
Empfehlener höchste Wassertemperatur.....	65°
Höchste einkommende Drucksunterschied (Warm - kalt).....	1.5 BAR

Betriebsanweisungen

Diese Mischer sind sowie für Heisswasserspeicher als auch für Durchlaufhitzer geeignet.

Note

Die Verbindungsröhre vor der Montage sorgfältig putzen.

Das warme Wasser muss **IMMER** mit dem linken **RÖHRCHEN ODER** Flexschlauch verbunden werden

ITALY.

Technical data

Minimum pressure.....	1 BAR
Maximum pressure.....	10 BAR
Recommended working pressure.....	2-5 BAR
Maximum water temperature.....	80°
Maximum water temperature recommended.....	65°
Maximum in-let pressure difference (hot - cold).....	1.5 BAR

Operating instructions

These mixers can be used with cumulos boilers or instantaneous water heaters.

Warning

The supplying pipes must be carefully cleaned before installation.

Remember that the hot water supply must **ALWAYS** be connected to the tube on the **LEFT**.

GERMANY.

Datos Técnicos

Pression mínima.....	1 BAR
Pression máxima.....	10 BAR
Pression de trabajo aconsejada.....	2-5 BAR
Temperatura máxima.....	80°
Temperatura máxima aconsejada.....	65°
Diferencial maxima de presión de entrada (caliente - fria).....	1.5 BAR

Aplicaciones

Estos monomandos pueden ser utilizados con acumuladores de agua caliente a presión.

Advertencias

Antes de conectar el monomando es necesario purgar correctamente la instalaci6n hidráulica de alimentaci6n de cualquier impureza que pueda tener.

Recuerde que el agua caliente debe ser **SIEMPRE** conectada al tubo o flexo de la **IZQUIERDA**.

ENGLAND.

Caractéristiques techniques

Pression minimum.....	1 BAR
Pression maximum.....	10 BAR
Pression optimale de service.....	2-5 BAR
Température maximum.....	80°
Température maximum optimale.....	65°
Différence maximum de Pression d'arrivée (chaud - froid).....	1.5 BAR

Mode d'emploi

Ces mitigeurs peuvent être utilisés avec accumulateurs d'eau chaude à pression ou avec des chauffe-eau instantanés.

Note

Il est indispensable que les raccords d'alimentation soient purgés avant la mise en place de l'appareil.

Se rappeler que l'eau chaude doit être **TOUJOURS** liée au petit tuyau ou au flexible de **GAUCHE**.

SPAIN.

FRANCE.

Cura del prodotto

La pulizia delle superfici va fatta utilizzando un sapone liquido diluito in acqua.

Non usare mai in nessun caso detersivi liquidi contenenti sostanze abrasive o a base di acido muriatico, spugne abrasive, aceto, ammoniaca, acetone, candeggina, acidi di uso domestico, disinfettanti vari.

ATTENZIONE! L'impiego di prodotti non consigliati può deteriorare irrimediabilmente le superfici, nel qual caso il produttore non risponderà del danno.

L'azienda si riserva in qualunque momento di apportare senza preavviso modifiche a prodotti e accessori.

I dati riprodotti in questo documento hanno carattere informativo e non sono vincolanti.

ITALY.**Advice on product care**

To clean the surface use a soap and water solution.

Never use for any reason cleaning solutions containing abrasive substances, chloric acids, ammonia, vinegar, bleach, domestic acids, disinfectants, or anytype of abrasive pad.

WARNING! Incorrect cleaning may permanently ruin the surface of the products and in such case the manufacturer may not be held liable for damage.

The Manufacturer reserves the right to modify product and accessories at any time without prior notice. Data, products and sketches included in this document are just for information and do not bind the producer.

ENGLAND.**Conseils pour l'entretien du produit**

La poussière en surface devra être faite en utilisant un savon liquide dilué dans l'eau.

Ne jamais utiliser en aucun cas des détergents liquides contenant des substances abrasives ou à base d'acide, nid'éponges abrasives, vinaigre, ammoniacque, acétone, eau de Javel, acides à usage domestique, désinfectants divers.

ATTENTION! L'emploi de produits non conseillés peut détériorer irrémédiablement la surface des articles pour lesquels le fabricant ne sera pas responsable.

La société se réserve le droit de modifier ses produits et ses accessoires à tout moment et sans préavis. Informations, produits et croquis reproduits dans ce documents sont de nature informative et ne sont pas contractuels.

FRANCE.**Pflege hinweise unserer artikel**

Zur Reinigung empfehlen wir Wasser und flüssige Seife.

Verwenden Sie bitte nie flüssige Reinigungsmittel, die Schmirgel, Salzsäure, Essig, Ammoniak, Aceton, Bleichlange, Desinfektionsmittel u.s.w. enthalten.

WARNUNG! Der Gebrauch solcher Mittel kann unsere Artikel beschädigen und in diesem Fall gewährt Hersteller keine Garantie.

Der Hersteller behält sich das Recht vor jederzeit Änderungen an seinen Produkten und Zubehörteilen ohne Vorbescheid vorzunehmen. Katalogangaben sowie Abbildungen, Maß- und Leistungsangaben sind unverbindlich.

GERMANY.**Consejos para el cuidado del producto**

La limpieza de las superficies se hace utilizando un jabón líquido diluido en agua.

No usar en ningún caso detergentes líquidos que contengan sustancias abrasivas ó a base de ácido clorhídrico, estropajossabrosivos, amoniaco, acetona, lejía, ácidos de uso doméstico, desinfectantes varios.

ATENCIÓN! El uso de productos desaconsejados puede danar irremediabilmente las superficies de los elementos, de lo cual el fabricante no se hará responsable en ningún caso.

La sociedad se reserva el derecho de modificar sus productos y accesorios en cualquier momento y sin previo aviso.

SPAIN.



Disegni e grafica: www.dipi-designs.com 1160000010000000 Rev. 0



**Australian Standard
Installation**

Products shall be installed in accordance with AS/NZS 3500 series of standards.
Installer shall ensure that the flow controlled aerator is tightened to prevent removal by hand.