

# ABOUTWATER

# 8059-8053

Istruzioni / Instructions / Instructions de Montage / Bedienungsanleitung / Instrucciones

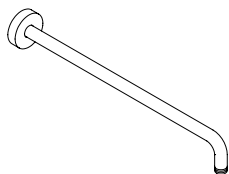

ART. 8059

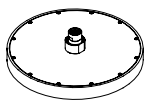

ART. 8053

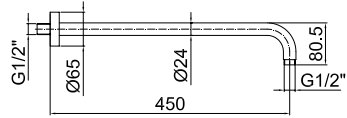
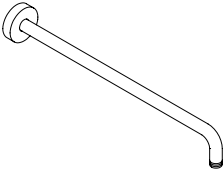

ART. 8059

Braccio doccia / Shower arm / Bras pomme de douche / Duscharm / Brazo de la ducha

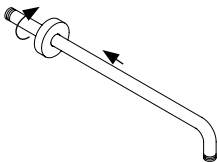

- Awitare la flangia al braccio
- Screw the flange to the arm
- Visser la bride au bras
- Den Flansch auf den Arm schrauben
- Atornillar la brida al brazo

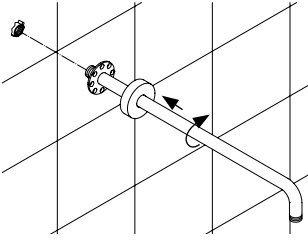

2.

- Avvitare il braccio al tubo installato nel muro
- Screw the arm to the tube installed in the wall
- Visser le bras au tube installé dans le mur
- Den Arm auf die Rohre in der Wand schrauben
- Atornillar el brazo al tubo instalado en el muro

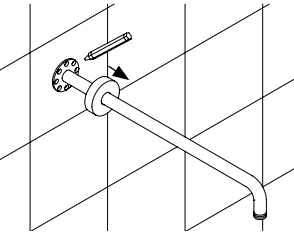

3.

- Con una matita segnare il posizionamento delle viti, utilizzando la flangia come dima, assicurandosi di non forare vicino al passaggio del tubo
- Using a pencil, mark the position of the screws using the flange as a template, ensuring not to drill near the route of the tube
- Avec un crayon, marquer la position des vis et, en utilisant la bride comme gabarit, vérifier de ne pas avoir percé à côté du passage du tube
- Mit Hilfe eines Bleistifts die Schraubenposition markieren, indem der Flansch wie eine Vorlage benutzt wird. N.B. nicht in der Nähe der Rohre bohren
- Con un lápiz marcar la posición de los tornillos, utilizando la brida como plantilla, asegurándose de no perforar cerca del recorrido de la cañería

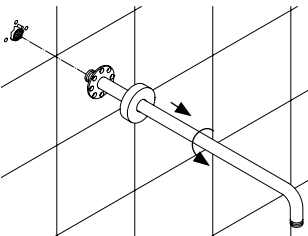

4.

- Svitare il braccio dal tubo
- Unscrew the arm from the tube
- Dévisser le bras du tube
- Den Arm von der Rohre abschrauben
- Desatornillar el brazo del caño

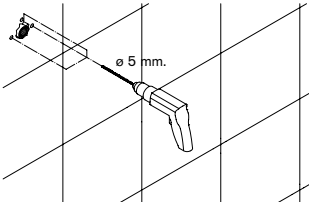

5.

- Forare il muro sui segni precedentemente posti
- Drill the wall using the marks made previously
- Perçer le mur sur les marques précédemment réalisées
- Die Wand nach den vorher gemachten Markierungen bohren
- Perforar el muro sobre las marcas hechas anteriormente

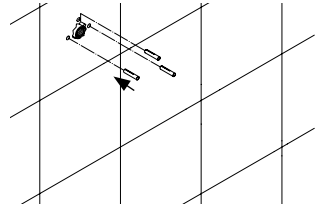

6.

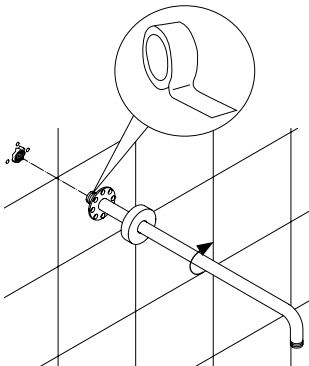

7.

- Mettere del teflon sull'innesto filettato del braccio
- Place some Teflon on the threaded joint of the arm
- Mettre du téflon sur l'embout fileté du bras
- Etwas Teflon auf die Schraubverbindung des Arms benutzen
- Colocar cinta de teflon sobre la rosca del brazo

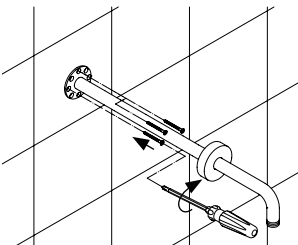

8.

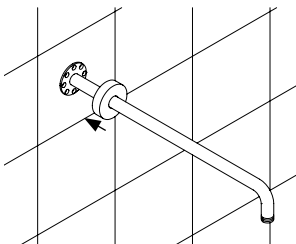

9.

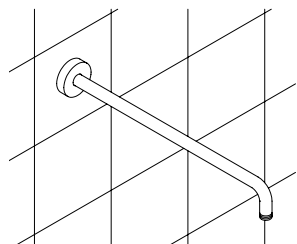

10.



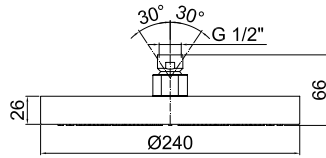
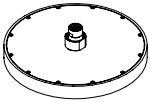

ART. 8053      Soffione / Shower head / Douche de tête / Duschkopf / Ducha

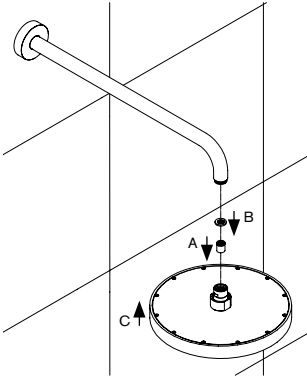

1.

- Il soffione é dotato di valvola antiritorno con limitatore di portata da 12l/min. Se si desidera una maggiore portata sostituire tale valvola con la valvola antiritorno senza limitazione di portata, in dotazione nella confezione.
- Showerhead with non-return valve and water supply of 12l/min. If you would like more water, replace this valve with the unrestricted non-return valve provided.
- La douche de tête est doté de soupape de non retour avec un limiteur de portée de 12l/min. Pour avoir une plus grande portée, remplacer cette soupape celle de non retour sans limiteur de portée jointe.
- Brausekopf mit selbstschließendem Ventil und Wasserzufuhr von 12l/Min. Wenn Sie mehr Wasser wünschen, ersetzen Sie dieses Ventil mit dem mitgelieferten selbstschließenden Ventil.
- La ducha està provista de una vàlvula de retención con limitador de caudal de 12 l/min. Si se desea un mayor caudal, reemplazar dicha vàlvula con la vàlvula de retención sin limitador de caudal, tambièn provista en la confección.

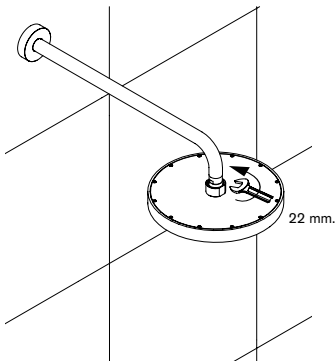

2.

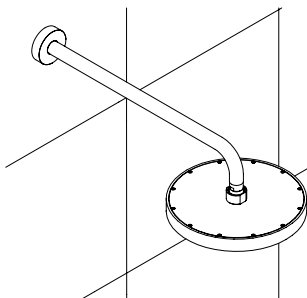

3.

Manutenzione / Maintenance / Entretien / Entretien / Mantenimiento

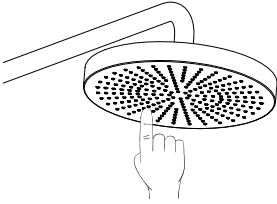

**1.**

- Periodicamente pulire gli ugelli del soffione come mostrato in figura
- It is advisable to periodically clean the showerhead nozzles as shown in the illustration.
- Il est recommandé de nettoyer périodiquement les becs de showerhead comme montré dans l'illustration.
- Es wird geraten, die Düsen des Brausekopfes regelmäßig wie in der Abbildung zu reinigen.
- Limpiar periódicamente los orificios de la ducha como se muestra en la figura



Tabella di portata / Flow chart / Diagramme / Flussdiagramm / Diagrama de flujo

descrizione	pressione						
	0	0,5	1	2	3	4	5
portata senza limitatore (l/min)	0	18	27	36	42	47	51
portata con limitatore (l/min)	0	8	10	11	11	12	12

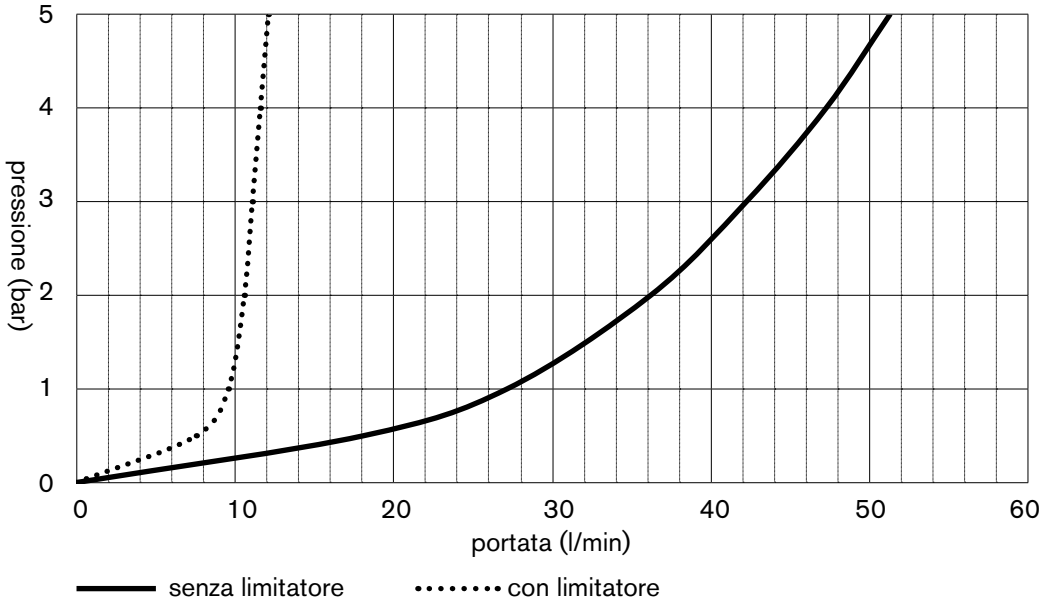

**Dati tecnici**

Pressione minima	1 BAR
Pressione massima	10 BAR
Pressione di esercizio consigliata	2-5 BAR
Temperatura massima	80°
Temperatura massima consigliata	65°

ITALY.

**Technische Daten**

Minimum druck	1 BAR
Höchste druck	10 BAR
Empfehlener druck	2-5 BAR
Höchste wasser Temperatur	80°
Empfehlener höchste Wassertemperatur	65°

GERMANY.

**Dati tecnici**

Minimum pressure	1 BAR
Maximum pressure	10 BAR
Reccomended working pressure	2-5 BAR
Maximum water temperature	80°
Maximum water temperature reccomended	65°

ENGLAND.

**Datos Técnicos**

Pression minima	1 BAR
Pression máxima	10 BAR
Pression de trabajo aconsejada	2-5 BAR
Temperatura máxima	80°
Temperatura máxima aconsejada	65°

SPAIN.

**Caractéristiques techniques**

Pression minimum	1 BAR
Pression maximum	10 BAR
Pression optimale de service	2-5 BAR
Température maximum	80°
Température maximum optimale	65°

FRANCE.

**Cura del prodotto**

La pulizia delle superfici va fatta utilizzando un sapone liquido diluito in acqua.

Non usare mai in nessun caso detersivi liquidi contenenti sostanze abrasive o a base di acido muriatico, spugne abrasive, aceto, ammoniaca, acetone, candeggina, acidi di uso domestico, disinfettanti vari.

**ATTENZIONE!** L'impiego di prodotti non consigliati può deteriorare irrimediabilmente le superfici, nel qual caso il produttore non risponderà del danno.

L'azienda si riserva in qualunque momento di apportare senza preavviso modifiche a prodotti e accessori. I dati riprodotti in questo documento hanno carattere informativo e non sono vincolanti.

ITALY.**Advice on product care**

To clean the surface use a soap and water solution.

Never use for any reason cleaning solutions containing abrasive substances, chloric acids, ammonia, vinegar, bleach, domestic acids, disinfectants, or anytype of abrasive pad.

**WARNING!** Incorrect cleaning may permanently ruin the surface of the products and in such case the manufacturer may not be held liable for damage.

The Manufacturer reserves the right to modify product and accessories at any time without prior notice. Datas, products and sketches included in this document are just for information and do not bind the producer.

ENGLAND.**Conseils pour l'entretien du produit**

La poussiere en surface devra être faite en utilisant un savon liquide dilué dans l'eau.

Ne jamais utiliser en aucun cas des détergents liquides contenant des substances abrasives ou à base d'acide, nid'éponges abrasives, vinaigre, ammoniacque, acétone, eau de Javel, acides à usage domestique, désinfectants divers.

**ATTENTION!** L'empli de produits non conseillés peut détériorer irrémédiablement la surface des articles pour lesquels le fabricant ne sera pas responsable.

La société se réserve le droit de modifier ses produits et ses accessoires à tout moment et sans préavis. Informations, produits et croquis reproduits dans ce documents sont de nature informative et ne sont pas contractuels.

FRANCE.**Pflege hinweise unserer artikel**

Zur Reinigung empfehlen wir Wasser und flüssige Seife.

Verwenden Sie bitte nie flüssige Reinigungsmittel, die Schmirgel, Salzsäure, Essig, Ammoniak, Aceton, Bleichlange, Desinfektionsmittel u.s.w. enthalten.

**WARNUNG!** Der Gebrauch solcher Mittel kann unsere Artikel beschädigen und in diesem Fall gewährt Hersteller keine Garantie.

Der Hersteller behalt sich das Recht vor jederzeit Änderungen an seinen Produkten und Zubehörteilen ohne Vorbescheid vorzunehmen. Katalogangaben sowie Abbindungen, Maß- und Leistungsangaben sind unverbindlich.

GERMANY.**Consejos para el cuidado del producto**

La limpieza de las superficies se hace utilizando un jabón liquido diluido en agua.

No usar en ningún caso detergentes líquidos que contengan sustancias abrasivas ó a base de ácido clorhídrico, estropajossabrosivos, amoniaco, acetona, lejía, ácidos de uso doméstico, desinfectantes varios.

**ATENCIÓN!** El uso de productos desaconsejados puede danar irremediamente las superficies de los elementos, de lo cual el fabricante no se hará responsable en ningún caso.

La sociedad se reserva el derecho de modificar sus productos y accesorios en cualquier momento y sin previo aviso.

SPAIN.

# ABOUTWATER

Disegni e grafica: [www.dipi-designs.com](http://www.dipi-designs.com) 1181000010000000 Rev. 3

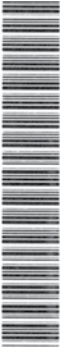

**Australian Standard  
Installation**

Products shall be installed in accordance with AS/NZS 3500 series of standards.  
Installer shall ensure that the flow controlled aerator is tightened to prevent removal by hand.