

# CONODUO FREESTANDING

- straightlined, purist design
- enamelled waste cover and overflow knob integrated in the bath design (also available with filling function)
- classic four-cornered model
- the moulded panel emphasises the high design standard and enables the bath to be free-standing
- bathing with a friend: two identical back rests and centrally positioned waste
- made of KALDEWEI steel enamel
- designed by Sottsass Associati

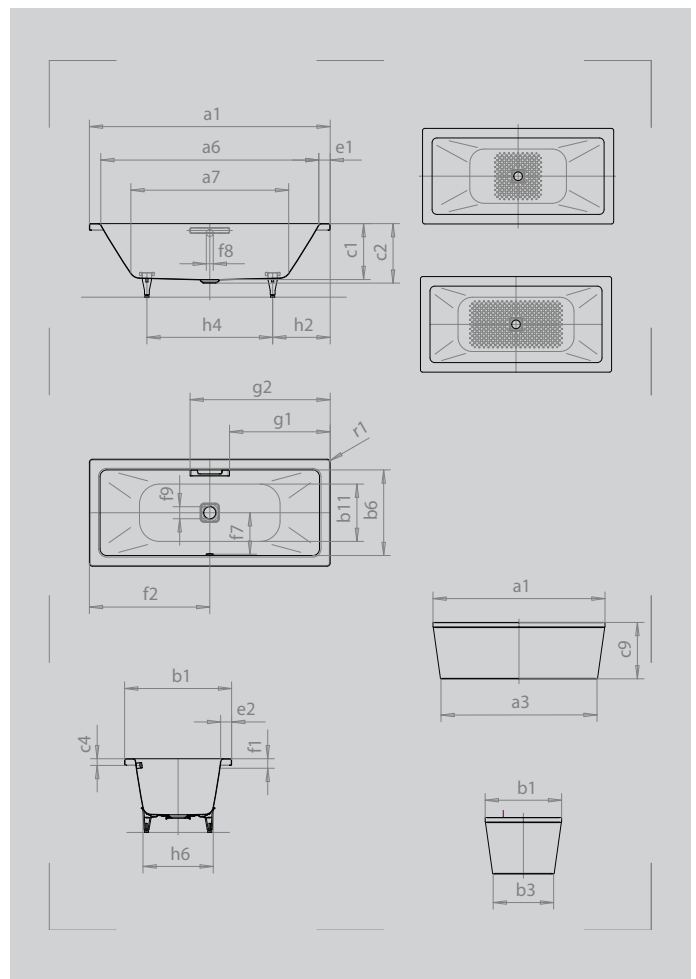

Similar illustration



GRIP ELEGANT PURISM



Model		733
External length	a <sub>1</sub>	1800 mm
External length (bottom)	a <sub>3</sub>	1633 mm
Internal length (top)	a <sub>6</sub>	1640 mm
Internal length (bottom)	a <sub>7</sub>	1180 mm
External width	b <sub>1</sub>	800 mm
External width (bottom)	b <sub>3</sub>	633 mm
Internal width (top)	b <sub>6</sub>	640 mm
Internal width (bottom)	b <sub>11</sub>	520 mm
Depth inside	c <sub>1</sub>	420 mm
Depth incl. waste hole	c <sub>2</sub>	445 mm
Height of rim	c <sub>9</sub>	50 mm
Overall height with panel	c <sub>9</sub>	590 mm
Width of rim (foot end; long side)	e <sub>1</sub> ; e <sub>2</sub>	80; 80 mm
Distance top edge to centre of overflow hole	f <sub>1</sub>	70 mm
Distance bath edge to centre of waste hole	f <sub>2</sub>	900 mm
Distance centre of waste hole to centre of overflow hole	f <sub>7</sub>	310 mm
Diameter of overflow hole	f <sub>8</sub>	Ø 52 mm
Diameter of waste hole	f <sub>9</sub>	Ø 90 mm
Distance bath edge (foot end) to start of grip	g <sub>1</sub>	752 mm
Distance bath edge (foot end) to end of grip	g <sub>2</sub>	1048 mm
Distance foot end of bath edge to centre of foot	h <sub>2</sub>	555 mm
Distance between the feet	h <sub>4</sub>	690 mm
Width of feet max.	h <sub>6</sub>	515 mm
External radius	r <sub>1</sub>	23 mm
Water volume		159 l
Net weight		85 kg
Anti-slip		404 x 404 mm
Full anti-slip		884 x 404 mm