

水栓取付穴

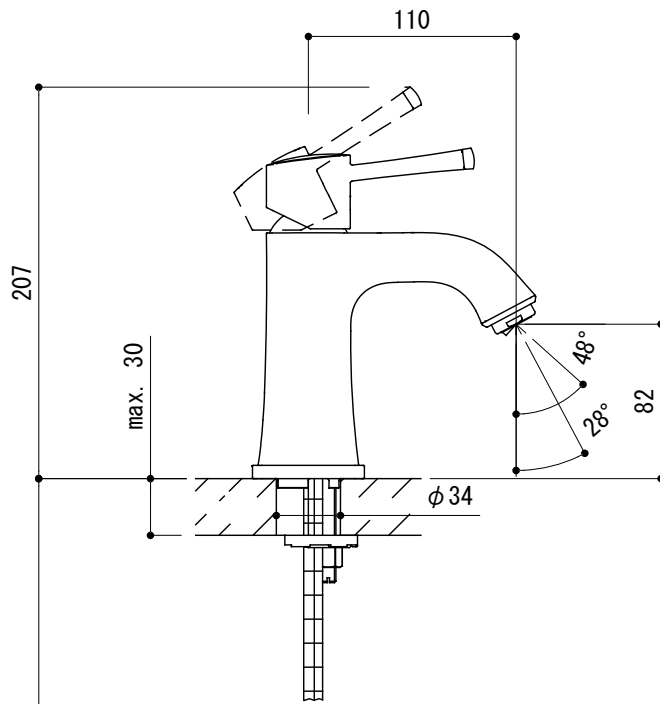

432

390

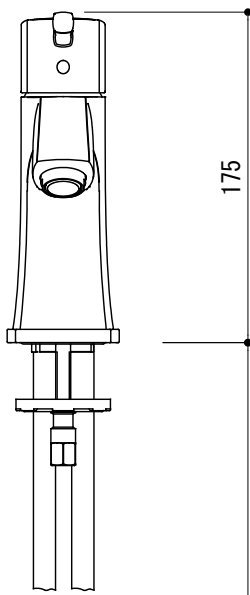
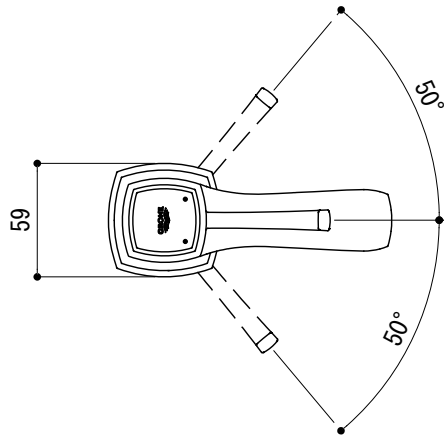
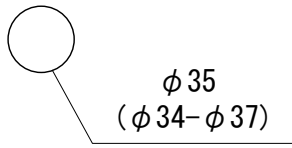
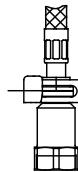
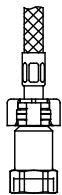
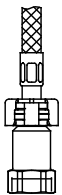

▲
G1/2"

FHT73-1102-F01 (クローム)
FHT73-1102-F04 (クローム/ゴールド)

品名 混合栓 -GROHE, Grandera-

品番 FHT73-1102

仕様

重量

容量

縮尺 1:4

大洋金物株式会社 ティーフォーム事業部 **Tform**